

15 CORNER PROTECTION

Designed to protect pillars and columns or external corners of walls and panels.

Corner Protection

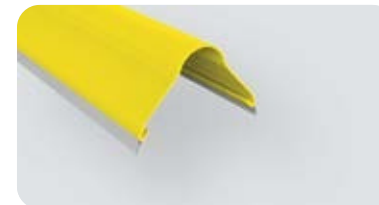

CP 100

Length **4.000 mm**
Packing **10 pz / bag**
Colour **B M E F**

Length **2.000 mm**
Packing **10 pz / bag**
Colour **M**

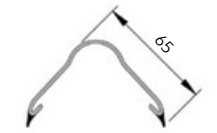

CPF 100

Length **4.000 mm**
Packing **10 pz / bag**

Length **2.000 mm**
Packing **10 pz / bag**



CPT 100

Packing **40 pz / box**
Colour **B E F**

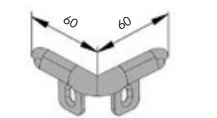

CP 200

Length **4.000 mm**
Packing **2 pz / bag**
Colour **B M E**

Length **2.000 mm**
Packing **2 pz / bag**
Colour **M**

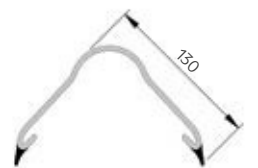

CPF 200

Length **2.000 / 4.000 mm**
Packing **2 pz / bag**

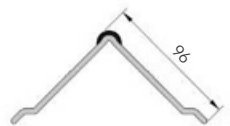

CPT 200

Packing **20 pz box**
Colour **B E**

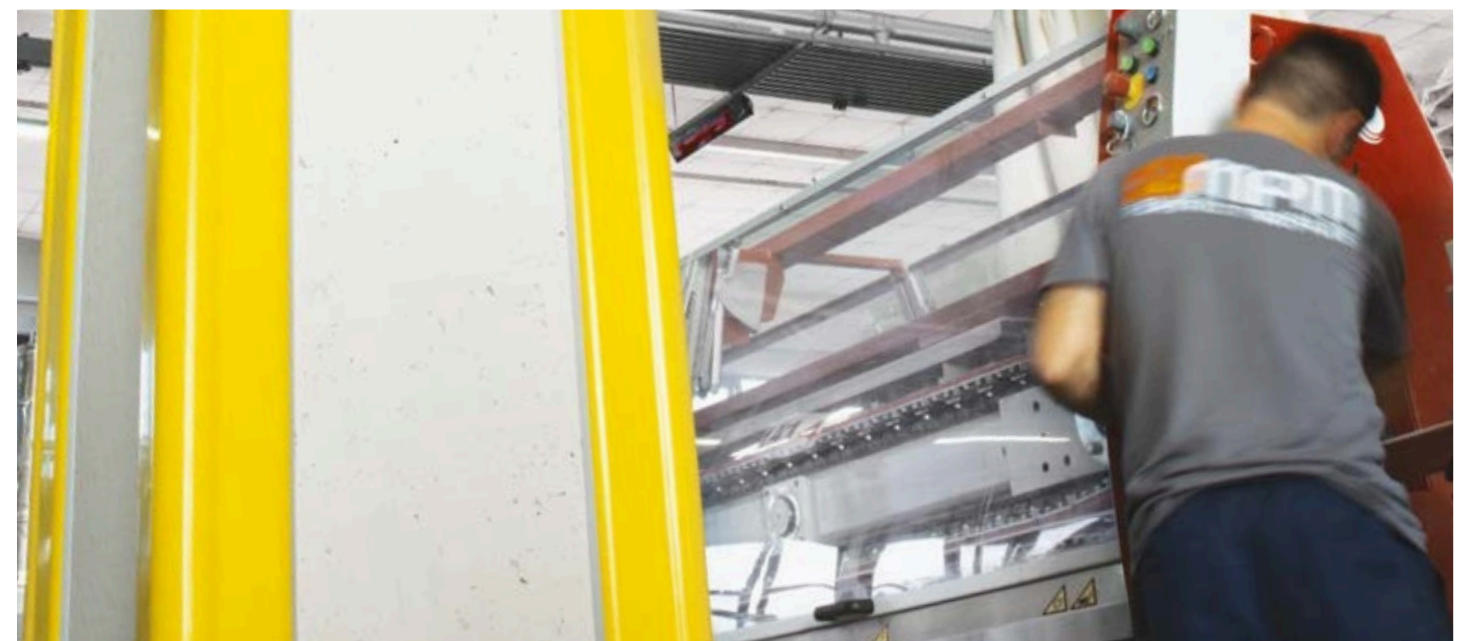
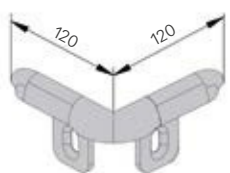

16

KERB

Large-sized protection system, ideal for walls and panels. Easy to install and clean. Fully equipped with corner caps and buttons.

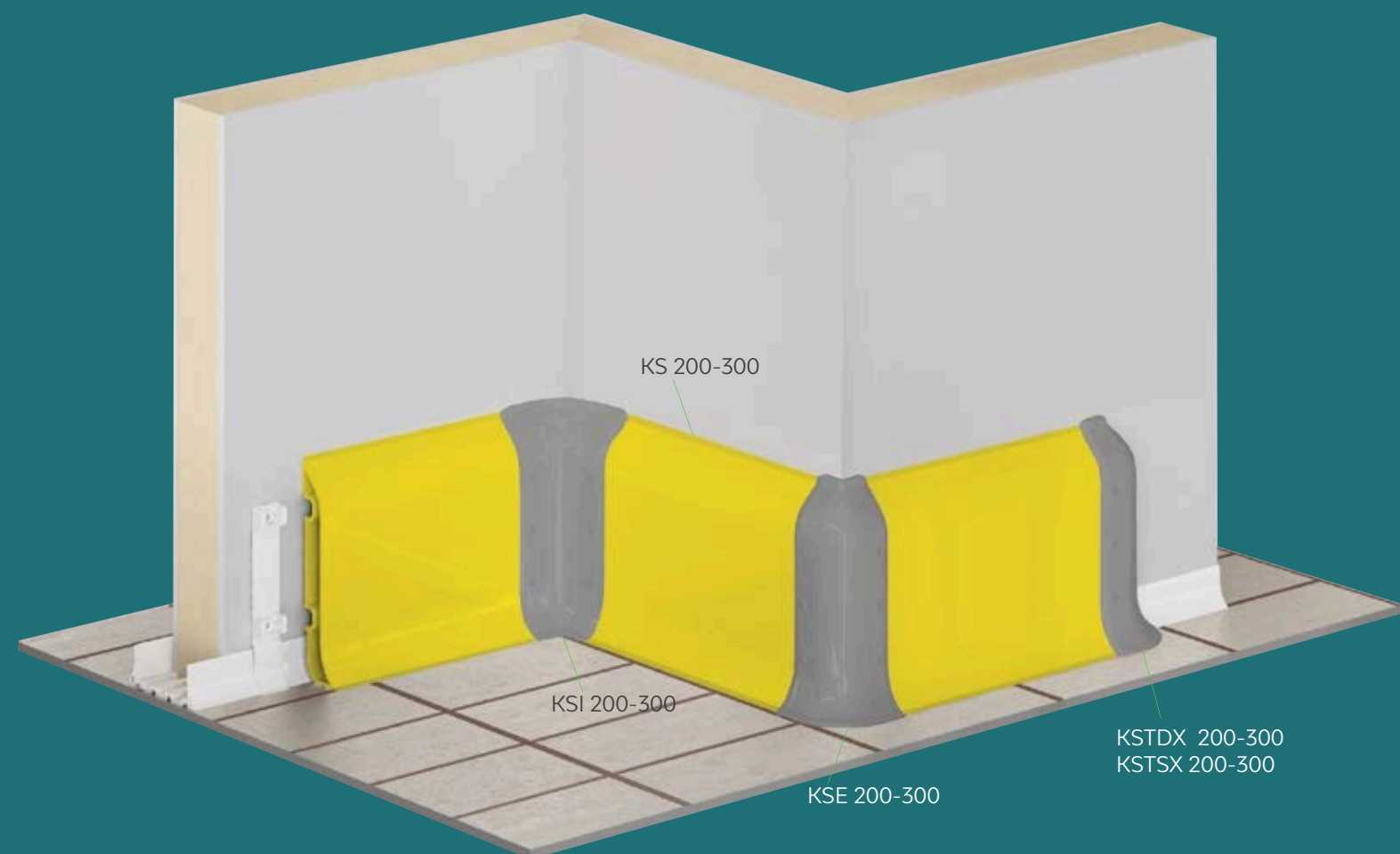

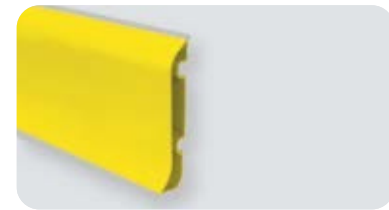

KS 200

Length **4.000 mm**
 Packing **3 pz / box**
 Colour **B M E**

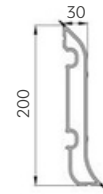

KEPF 200
 Fixing to be defined

Packing **50 pz / box**
 Colour **K**

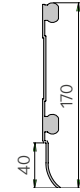

KSJ 200
 To install with TB14 / TF14

Packing **20 pz / box**
 Colour **B E**

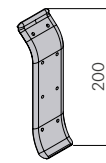

KSI 200
 To install with TB14 / TF14

Packing **20 pz / box**
 Colour **B E**

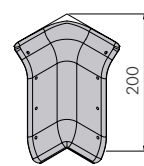

KSE 200
 To install with TB14 / TF14

Packing **20 pz / box**
 Colour **B E**

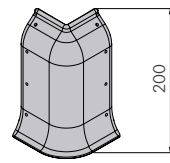

KSTD/SX 200
 To install with TB14 / TF14

Packing **20 pz / box**
 Colour **B E**

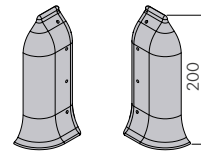

KSJ 200 LT

**THERMAL
 BREAK
 RESISTANT**

Packing **to be defined**
 Colour **K**

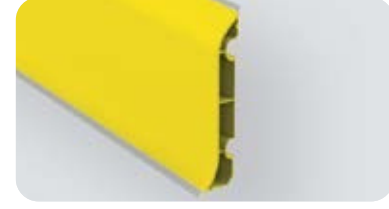
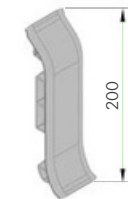

KS 300

Length **4.000 mm**
 Packing **1 pz**
 Colour **M E**

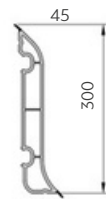

KEPF 300
 Fixing to be defined

Packing **20 pz / box**

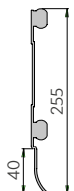

KSJ 300.

To install with TB20 / TF20

Packing **10 pz / box**
 Colour **B E**

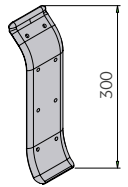

KSI 300

To install with TB20 / TF20

Packing **10 pz / box**
 Colour **B E**

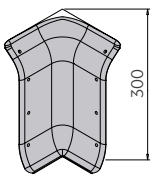

KSE 300

To install with TB20 / TF20

Packing **10 pz / box**
 Colour **B E**

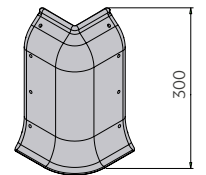

KSTD/SX 300

To install with TB20 / TF20

Packing **10 pz / box**
 Colour **B E**

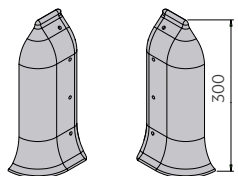

17 WALL PROTECTION

New bumper without guides. Thanks to its big size and resistance it is ideal for protection of industrial spaces. Fixed caps with hidden screws covered by specific buttons.

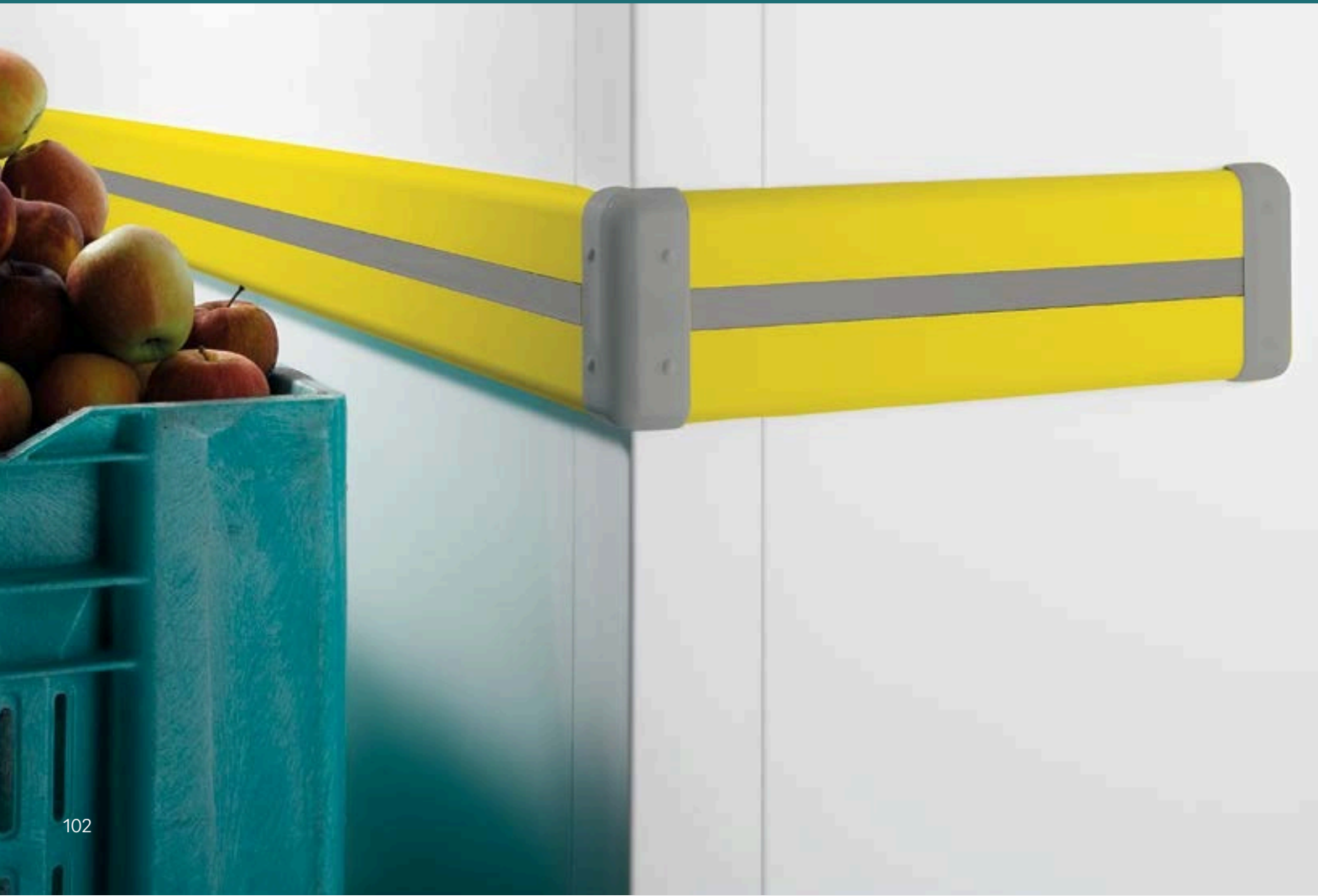

Wall Protection



WP 100

Length **4.000 mm**
Packing **8 pz / box**
Colour **B E F**

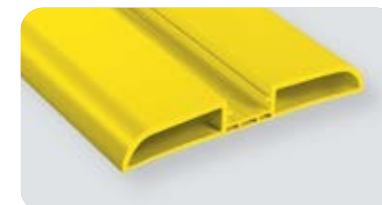
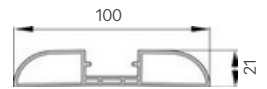

WP 150

Length **4.000 mm**
Packing **4 pz / box**
Colour **B M E**

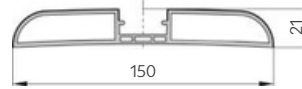

WPC

To install with WP 100 / WP 150

Length **4.000 mm**
Packing **16 pz / box**
Colour **A B M D E F G H**

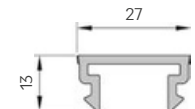

WPT 100

To install with TM5

Packing **50 pz / box**
Colour **B E F**

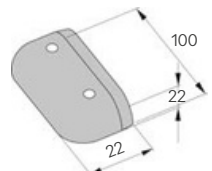

WPA 100

To install with TS9

Packing **20 pz / box**
Colour **B E**

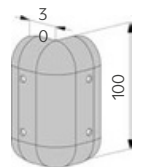

WPT 150

To install with TM5

Packing **50 pz / box**
Colour **B E**

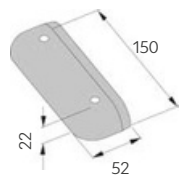

WPA 150

To install with TS9

Packing **20 pz / box**
Colour **B E**

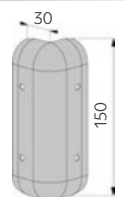

Wall Protection



WP 100

Length **4.000 mm**
Packing **8 pz / box**
Colour **B E F**

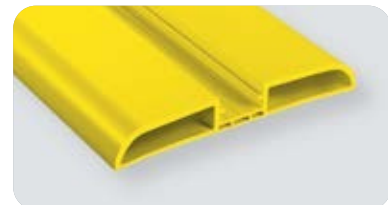
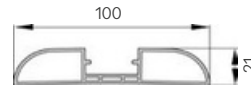

WP 150

Length **4.000 mm**
Packing **4 pz / box**
Colour **B M E**

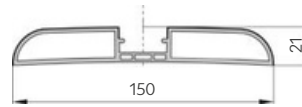

WPCS

To install with WP 100 / WP 150



Length **4.000 mm**
Packing **8 pz / box**
Colour **A B M D E F G H I**

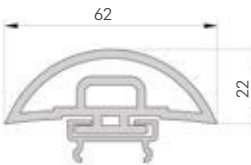

WPTS 100

To install with TS9

Packing **20 pz / box**
Colour **B E**

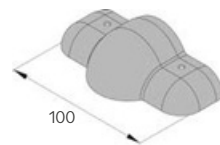

WPAS 100

To install with TS9

Packing **20 pz / box**
Colour **B E**

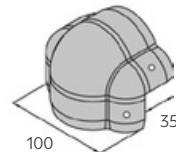

WPTS 150

To install with TS9

Packing **20 pz / box**
Colour **B E**

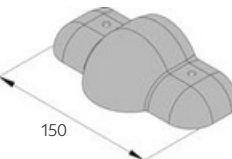

WPAS 150

To install with TS9

Packing **20 pz / box**
Colour **B E**

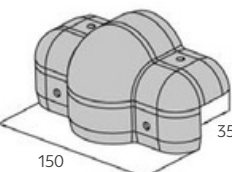

Wall Protection

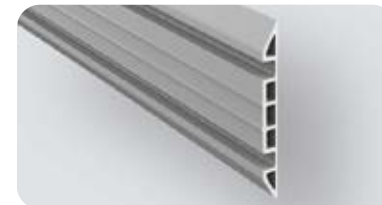
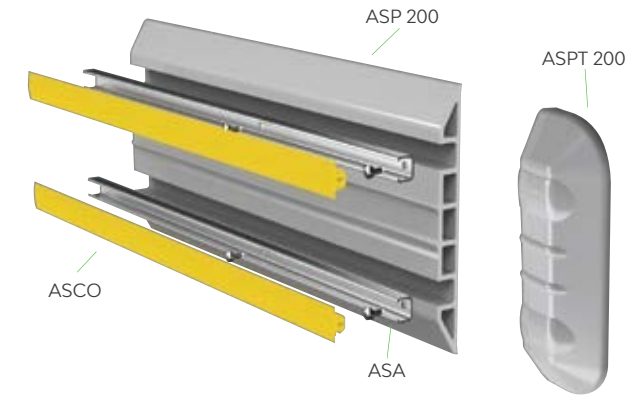

ASP 200



Length **4.000 mm**
Packing **2 pz / box**
Colour **B**

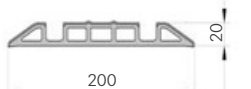

ASPT 200



Packing **10 pz / box**
Colour **B D**

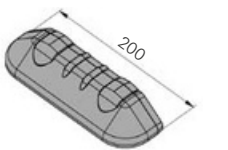

ASA.

Material **aluminium**
Length **4.000 mm**
Packing **8 pz / bundle**

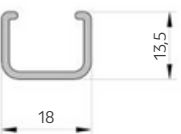

ASCO



Packing **2 pz / box**
Colour **L = 32.000 mm**
Colour **A B M D G**

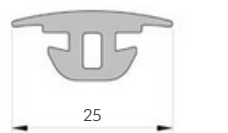



WALL HUG
1000
2000
3000
4000

Length **1000/2000/3000/4000**
Packing **unpacked**
Colour **M**

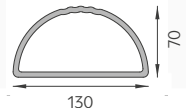

WALL BFLEX
1000
2000
3000
4000

Length **1000/2000/3000/4000**
Packing **unpacked**
Colour **M**

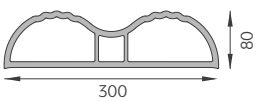

WALL BFLEX MODULAR

Packing **unpacked**
Colour **M**

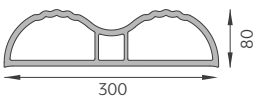

NEWS



LOFT BARRIER
WORLD'S FIRST FIXED PROTECTION SYSTEM FOR SUSPENDED AREAS

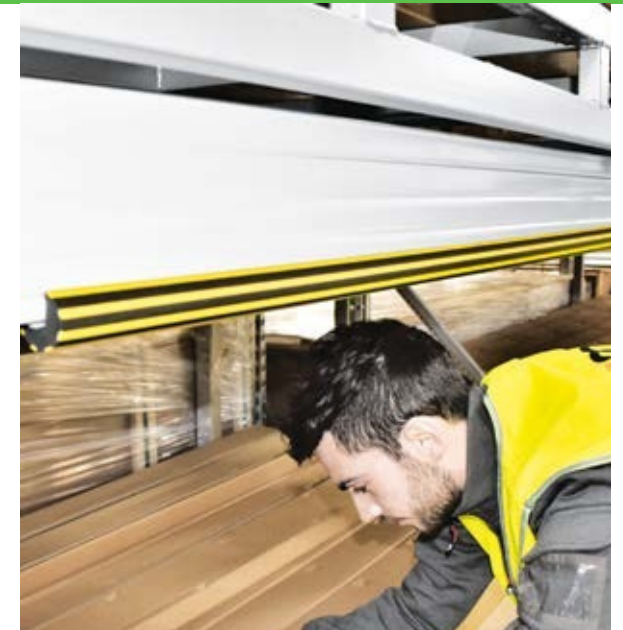

FLEXI LINE
CORNER BUMPER GUARDS



FENCE LINK
STRONG ADAPTABLE SOLUTION FOR RACK-ENDS



CUSTOMISED RACK PROTECTOR, new version rack protector

CUSTOMISED RACK PROTECTOR